

ACCELEVO

ACCÉLÉRATEUR FREIN TIRER POUSSER

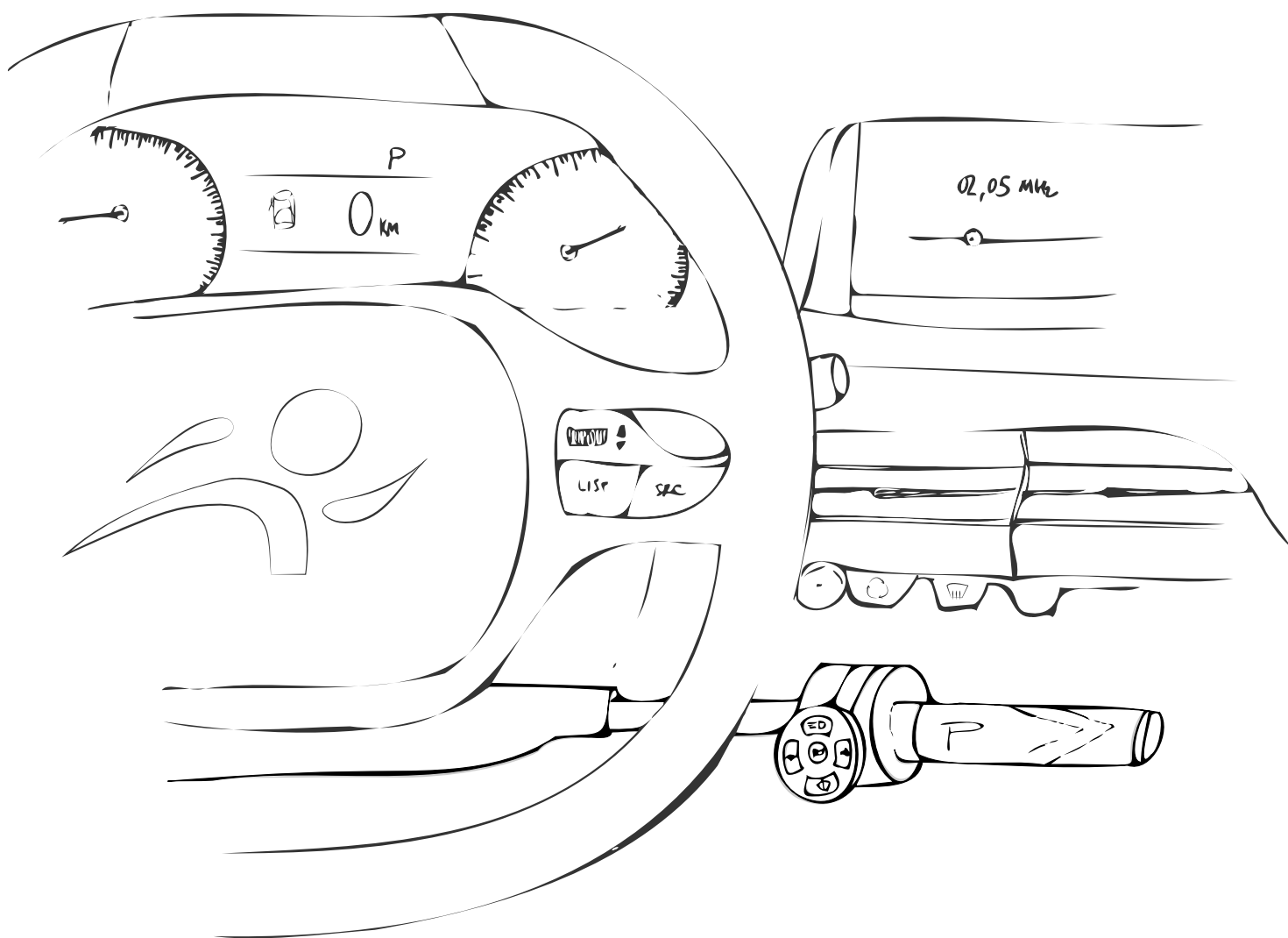

sojadis
PLUG & DRIVE

www.sojadis.com



SOMMAIRE

L'ACCELEVO en bref	3
Utilisation	4
Entretien	6
Garantie	7
Pannes et solutions	8
Roulons ensemble	9
Glossaire	10

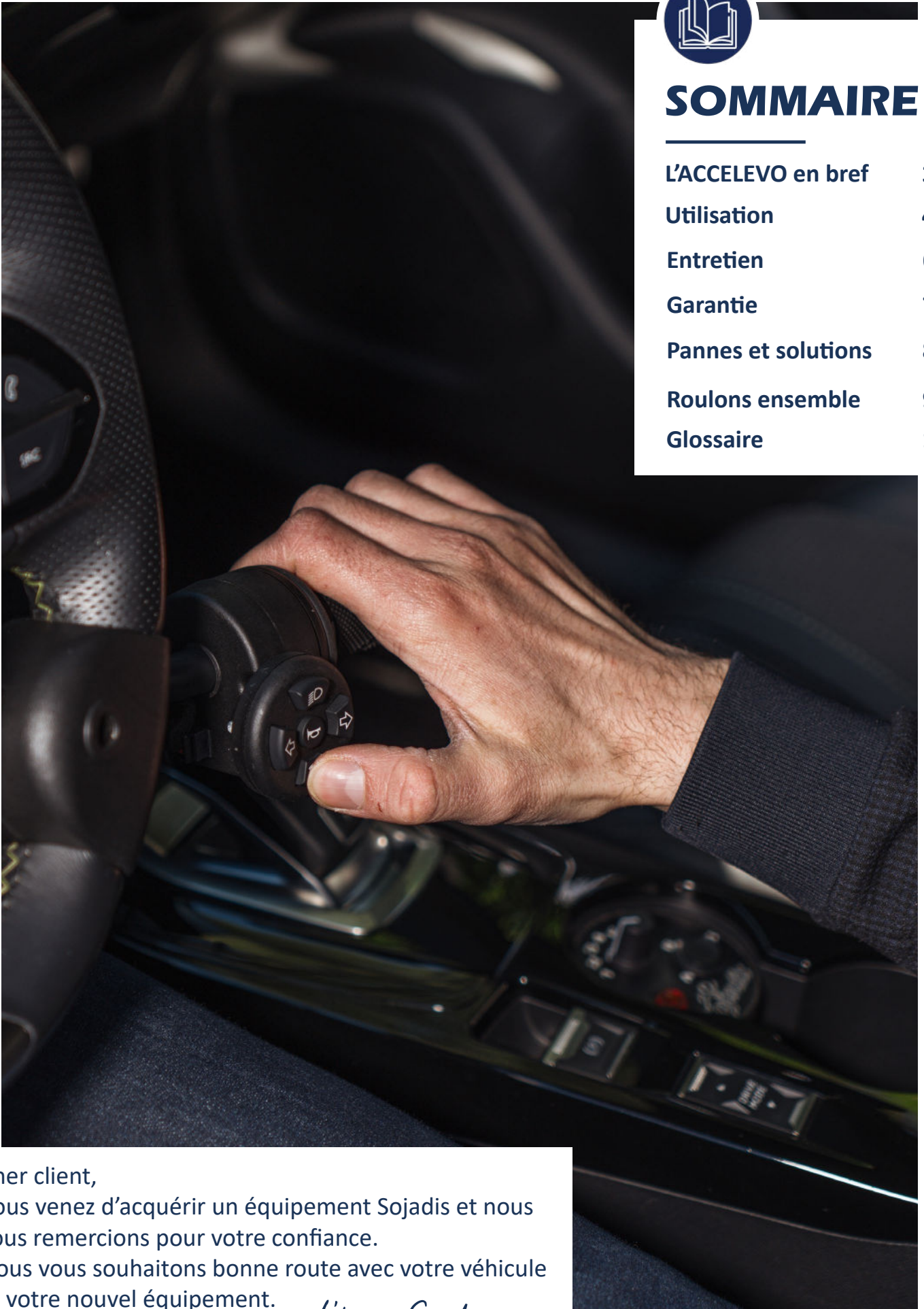

Cher client,
Vous venez d'acquérir un équipement Sojadis et nous vous remercions pour votre confiance.
Nous vous souhaitons bonne route avec votre véhicule et votre nouvel équipement.

L'équipe Sojadis



L'ACCELEVO EN BREF

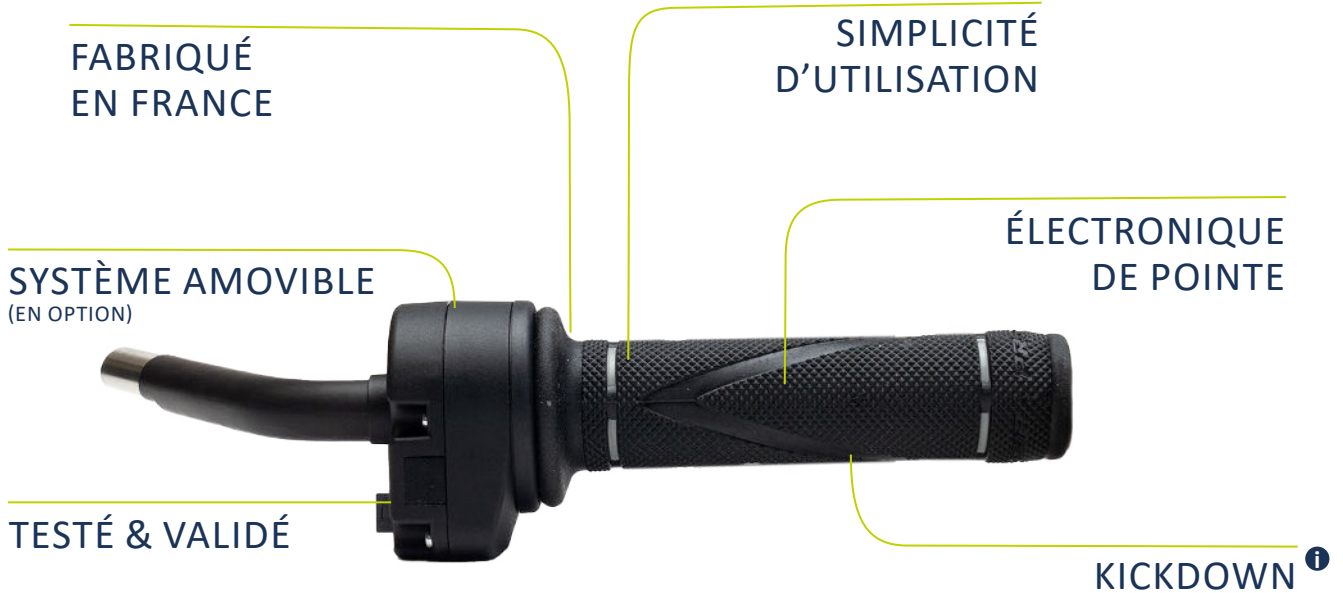

OPTION MINI-CLAVIER

Avertisseur sonore

Clignotant gauche

- Allumer / éteindre **Impulsion**
- Lave-glace avant **Appui maintenu**

Essuie-glaces avant

- Petite vitesse **1^{ère} impulsion**
- Grande vitesse **2^{ème} impulsion**
- Arrêt des essuie-glaces **Appui maintenu**

Phares

- Feux de croisement **1^{ère} impulsion**
- Feux de route **2^{ème} impulsion**
- Extinction des feux **Appui maintenu**

Clignotant droit

- Allumer / éteindre **Impulsion**
- Blocage du frein **Appui maintenu (en option)**

Clavier rétro-éclairé



UTILISATION



RECOMMANDATIONS

ACTIVATION

Il faut activer l'équipement dans les 30 secondes. Au delà, il est nécessaire de redémarrer le véhicule et de recommencer les étapes du mode d'emploi.

Suite à l'activation de l'ACCELEVO, la pédale d'accélération d'origine est désactivée.



DÉMARRER

Ne pas toucher à l'ACCELEVO lors du démarrage du véhicule.

MINI-CLAVIER

Au démarrage du véhicule le MINI-CLAVIER de l'ACCELEVO est actif contrairement à l'ACCELEVO qui est inactif (pas d'accélération).

MODE D'EMPLOI

1 DÉMARRER LE VÉHICULE

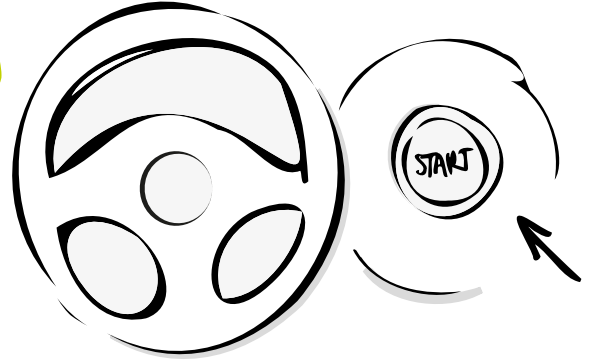

2 APPUYER SUR LE BOUTON D'ACTIVATION

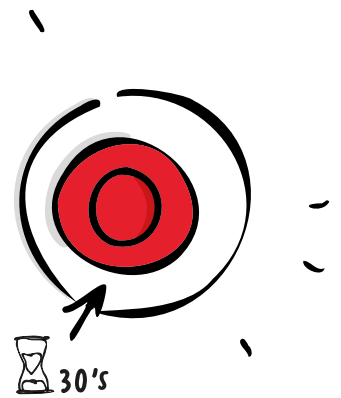

3 UTILISER VOTRE ÉQUIPEMENT

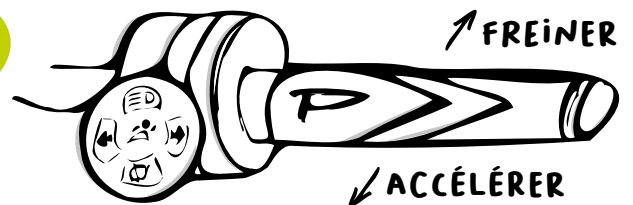

VOUS PRÉFÉREZ UNE VIDÉO ?

Cliquez ici ou scannez le QR-Code.





SÉCURITÉ

Grâce à l'électronique embarquée par l'ACCELEVO, freiner désactive automatiquement l'accélération.



RETOUR EN CONFIGURATION D'ORIGINE

Pour revenir en configuration d'origine (équipement d'adaptation désactivé), couper le moteur puis redémarrer le véhicule.



LIMITEUR DE VITESSE

Pour désactiver le limiteur de vitesse (lors d'un dépassement par exemple), tirer fortement sur l'équipement d'accélération.



MONTAGE ET DÉMONTAGE

(OPTION)

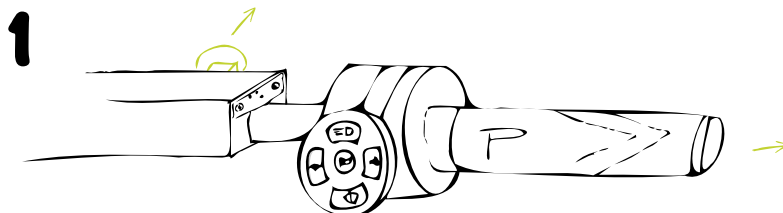

2

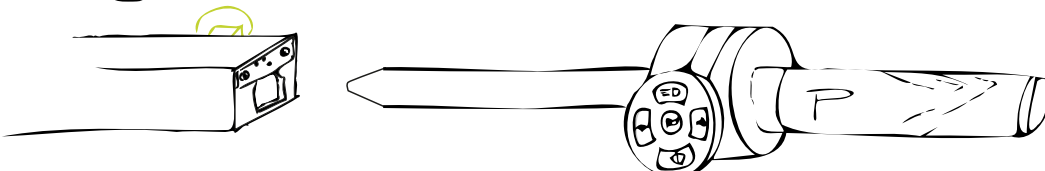

MINI-CLAVIER (OPTION)



ACTIVATION & DÉSACTIVATION

Lorsqu'une fonction est activée avec le MINI-CLAVIER, elle doit impérativement être désactivée avec ce dernier.

À la coupure moteur du véhicule, les commandes du MINI-CLAVIER en cours d'utilisation sont automatiquement éteintes. Suivant votre configuration, les fonctions peuvent être réactivées au prochain démarrage.



BLOCAGE FREIN

Ne jamais tirer sur la commande frein pour débloquent le frein. Suivre la méthode de blocage/déblocage page 5 de la notice STOPDIS.



ENTRETIEN

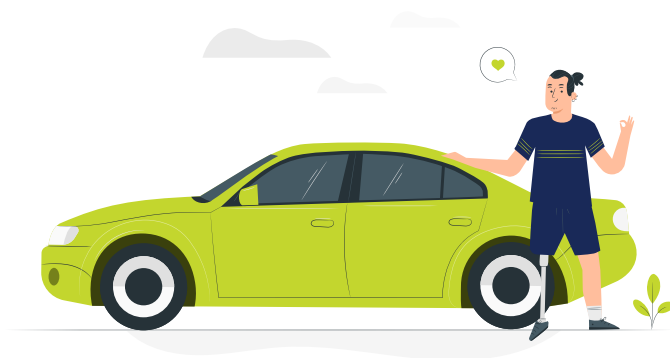

NOS CONSEILS



NETTOYAGE

L'ACCELEVO ne nécessite aucun entretien particulier.
Attention, l'usage de produits peut endommager le fonctionnement de l'équipement.



DÉPOUSSIÉRAGE

Pour dépeussier l'ACCELEVO, utiliser un chiffon doux de type microfibre.

Pour toute opération de maintenance, contacter notre atelier ou un installateur partenaire Sojadis. ¹



GARANTIE



EN BREF

2
ANS

C'est le délai durant lequel s'applique la garantie légale.



La garantie légale de conformité donne droit à la réparation ou au remplacement du produit dans un délai de 30 jours suivant votre demande.



La garantie ne s'applique pas dans les cas suivants : mauvaise utilisation du produit, accident, etc.

EN SAVOIR PLUS



DÉPOSE ÉQUIPEMENT

Vous souhaitez vendre votre véhicule équipé ou déposer votre équipement ?

Contactez-nous
+33 2 41 64 05 58
sojadis@sojadis.com



VALIDATION DES PRODUITS

Découvrez ce que nous faisons pour tester et valider la fiabilité de nos équipements tout au long de leur conception.



Cliquez ici ou scannez le QR-Code



PANNES ET SOLUTIONS



SERVICE APRÈS-VENTE

Notre service après-vente est à votre disposition pour diagnostiquer, dépanner et trouver des solutions à vos interrogations.

Munissez-vous de votre carte grise en cas de SAV.



+33 2 41 64 05 58

(du lundi au jeudi de 8h30 à 18h
et le vendredi de 8h30 à 17h)



sojadis@sojadis.com



www.sojadis.com

(via notre formulaire de contact)



AUTODIAGNOSTIC



Suite au démarrage de ma voiture mon équipement ne fonctionne pas

Vérifier le fonctionnement du bouton d'activation (bouton rouge) cf. page 4 dans mode d'emploi.



Mon accélération n'est pas fluide

L'ACCELEVO a du mal à coulisser. Nous contacter ou se rapprocher de l'installateur partenaire Sojadis le plus proche.

Le voyant défaut moteur s'affiche sur mon tableau de bord

Nous contacter ou se rapprocher de votre installateur le plus proche.



RÉSEAU INSTALLATEURS

En cas de panne, contacter directement l'atelier Sojadis ou l'installateur partenaire Sojadis ayant réalisé l'adaptation du véhicule.



**CARTE
INSTALLATEURS
PARTENAIRES**

Cliquez ici ou
scannez le QR-Code



ROULONS ENSEMBLE



Emmener ses enfants à l'école, au match de basket, retrouver ses amis, partir en week-end... Nous aspirons tous à pouvoir nous déplacer facilement, à pouvoir faire face au quotidien sans dépendre des autres, à pouvoir se réaliser en tant que femme ou homme, en bref, à mener sa vie.

DRIVE YOUR LIFE*, c'est la philosophie qui anime toute l'équipe de Sojadis :

«Notre entreprise développe et fabrique des solutions techniques, embarquant une connaissance et un savoir-faire en électronique de pointe aussi rares que précieux. Mais ce qui fait la valeur ajoutée de cette expertise, c'est notre volonté de permettre au plus grand nombre de pouvoir conduire en toute sécurité et en toute sérénité, pour la réalisation de leurs projets de vie.»

Adeline HUMEAU, Présidente de Sojadis

*Drive Your Life est le slogan de Sojadis. Cela signifie «Conduis ta vie».



LAISSEZ-NOUS VOTRE AVIS

Votre avis compte. Aidez-nous à nous améliorer en partageant vos impressions.

Merci d'avance !



Cliquez ici ou scannez le QR-Code

Bonne route



GLOSSAIRE

- KICKDOWN** Le kickdown est une fonction des voitures automatiques qui rétrograde la vitesse lorsque l'on appuie à fond sur l'accélérateur.
- BOUTON D'ACTIVATION** Le bouton d'activation devient rouge lorsque l'équipement est actif. Attention, ce n'est pas un bouton on/off. Pour désactiver l'équipement, il faut couper le moteur du véhicule.



- INSTALLATEUR PARTENAIRE SOJADIS** Les installateurs partenaires sont des garages automobiles qui ont choisi de rejoindre le réseau Sojadis pour proposer à leurs clients des aménagements de véhicules pour personnes en situation de handicap et des transformations auto-école. Ils sont tous formés et accompagnés par Sojadis afin de garantir la qualité des produits et services proposés. Grâce à ce réseau, chaque utilisateur peut bénéficier de l'expertise et des valeurs de Sojadis, près de chez lui.



POUR EN SAVOIR PLUS

Cliquez ici ou scannez le QR-Code

CONTACT

 Place du Maréchal Leclerc
Jallais
49510 BEAUPRÉAU-EN-MAUGES
FRANCE

 +33 2 41 64 05 58

 sojadis@sojadis.com

 www.sojadis.com

Suivez-nous sur nos réseaux sociaux





www.sojadis.com

ACCELEVO

ACCELERATOR AND BRAKE HANDLE

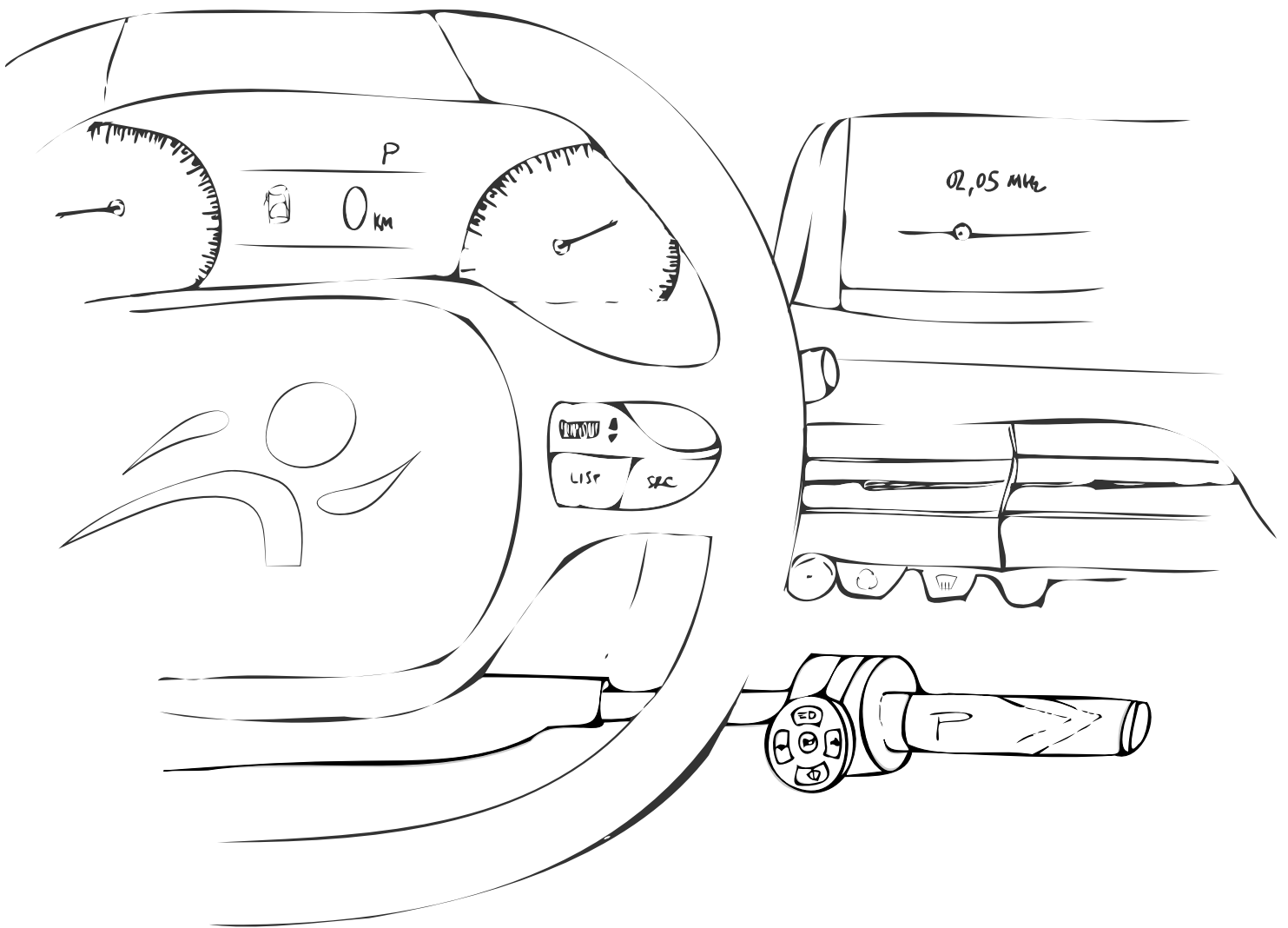

sojadis
PLUG & DRIVE

www.sojadis.com



CONTENTS

ACCELEVO's Overview	15
Usage	16
Maintenance	18
Warranty	19
Q&A	20
Let's drive together	21
Glossary	22

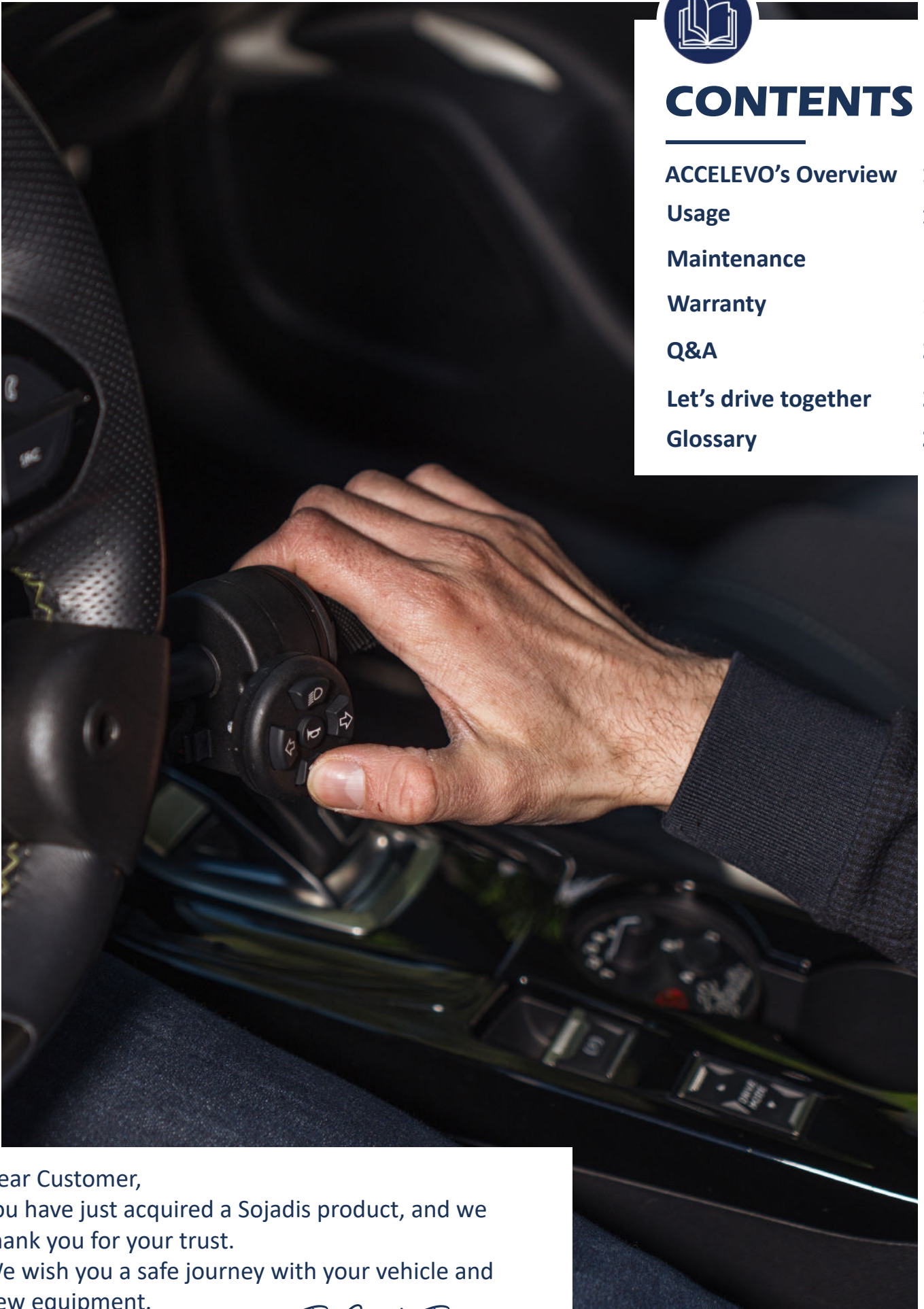

Dear Customer,
You have just acquired a Sojadis product, and we thank you for your trust.
We wish you a safe journey with your vehicle and new equipment.

The Sojadis Team



ACCELEVO'S OVERVIEW



MINI KEYPAD (OPTIONAL) :





USAGE



RECOMMENDATIONS

ACTIVATION

The equipment must be activated within 30 seconds. After that, the vehicle must be restarted and repeat the instructions.

When the ACCELEVO is activated, the original accelerator pedal is deactivated.



START

Do not press the ACCELEVO when starting the vehicle.

MINI KEYPAD

When the vehicle is started, the MINI KEYPAD is active, whereas the ACCELEVO is inactive (no acceleration).

INSTRUCTIONS

1 START THE VEHICLE

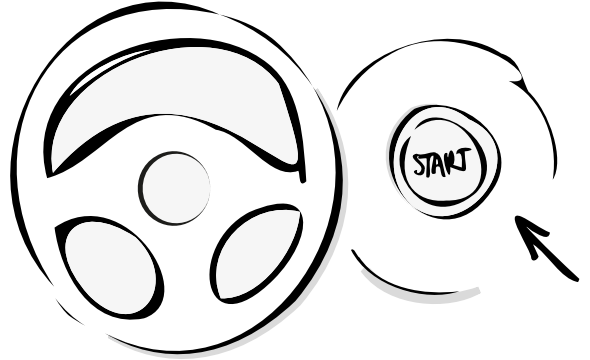

2 PRESS THE ACTIVATION BUTTON 

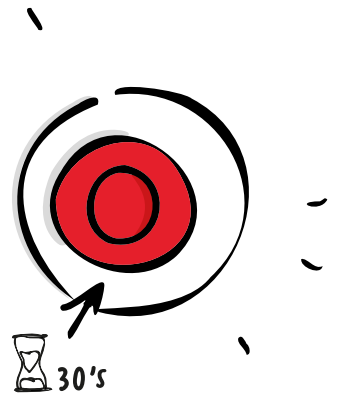

3 USE YOUR EQUIPMENT

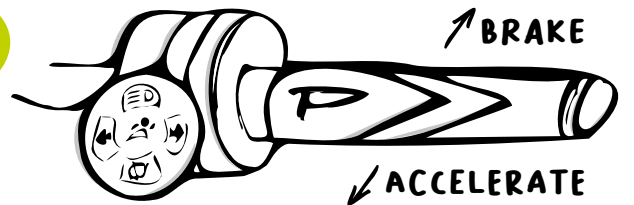

PREFER A VIDEO ?

Click or scan the QR-Code.





SAFETY

Thanks to the electronics on board the ACCELEVO, braking automatically deactivates acceleration.



RETURN TO ORIGINAL CONFIGURATION

To return to the original configuration (adaptation equipment deactivated), switch off the engine and then restart the vehicle.



SPEED LIMITER

To deactivate the speed limiter (when overtaking, for example), press hard on your accelerator.



ASSEMBLY AND DISASSEMBLY (OPTIONAL)

1

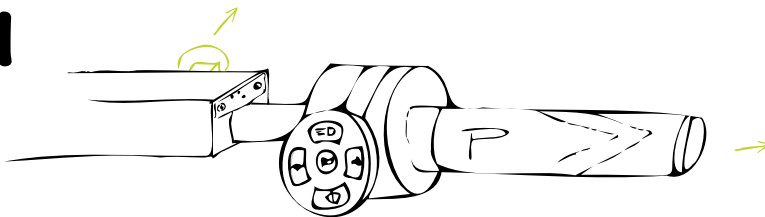

2

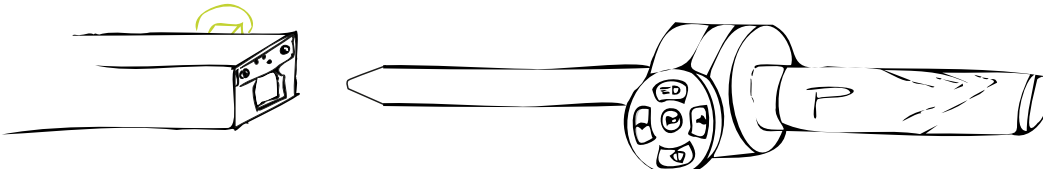

MINI KEYPAD (OPTIONAL)



ACTIVATION & DEACTIVATION

When a function is activated using the MINI KEYPAD, it must be deactivated using the MINI KEYPAD.

When the vehicle's engine is switched off, the MINI KEYPAD controls in use are automatically switched off. Depending on your configuration, the functions can be reactivated the next time the vehicle is started.



LOCKING THE BRAKE

Never pull on the brake lever to release the brake. Follow the locking/unlocking method on page 17 of the STOPDIS manual.



MAINTENANCE

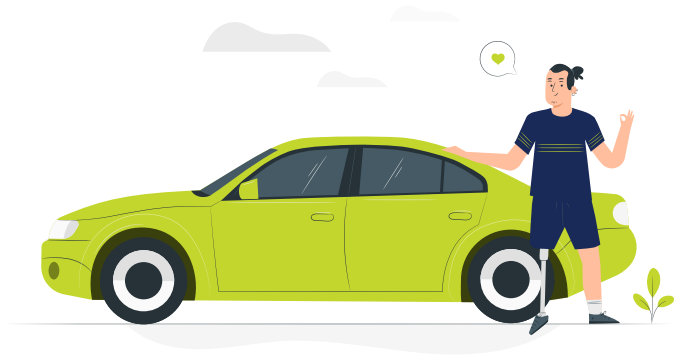

OUR ADVICE



CLEANING

The ACCELEVO requires no special maintenance. Caution: Using products may cause damage to the functioning of the equipment.



DUSTING

To remove dust from the ACCELEVO, use a soft microfibre cloth.

For all maintenance operations, contact our workshop or a Sojadis partner installer. ⁱ



WARRANTY



IN BRIEF

2
YEARS

This is the period during which the legal warranty applies.



The legal guarantee of conformity entitles you to have the product repaired or replaced. Contact your installation partner to find out how long this will take.



The warranty does not apply in the following cases: misuse of the product, accident, etc.

FIND OUT MORE



EQUIPMENT REMOVAL

Would you like to sell your equipped vehicle or remove your equipment?

Contact Sojadis or your local partner.



PRODUCT VALIDATION

Find out what we do to test and validate the reliability of our equipment throughout the design process.



Click here or scan the QR-Code



Q&A



AFTER-SALES SERVICE

Our after-sales service is at your disposal to diagnose, troubleshoot and find solutions to your problems. Please have your vehicle registration document ready in case of after-sales service.



+33 2 41 64 05 58

(Monday to Thursday from 8.30am to 6pm and Friday from 8.30am to 5pm)



sojadis@sojadis.com



www.sojadis.com

(via our contact form)



AUTODIAGNOSTIC



After starting my car, my equipment does not work

Check that the activation button (red button) is working (see operating instructions page).



My acceleration is not smooth

Your ACCELEVO is having trouble sliding. Contact us or your nearest Sojadis partner installer.



Impression of loss of acceleration

Contact us or your nearest Sojadis installer.



INSTALLER NETWORK

In the event of a breakdown, contact the Sojadis workshop directly or the Sojadis partner installer who fitted the vehicle.



**PARTNER
INSTALLER MAP**

Click or scan
the QR-Code

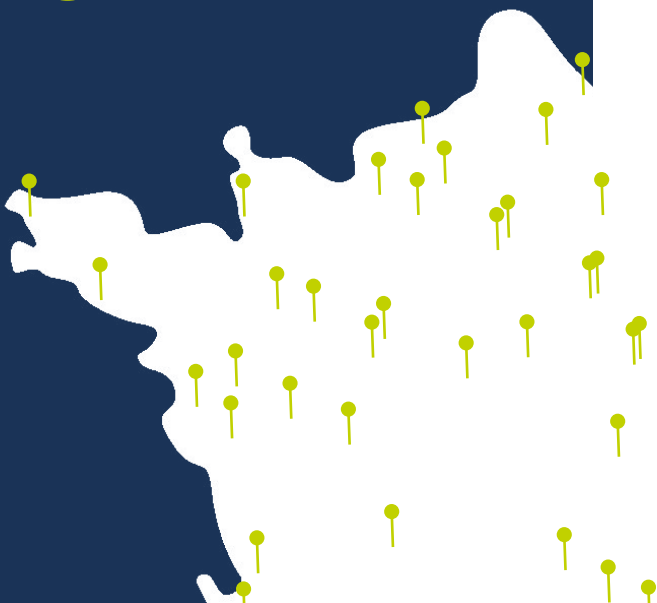



LET'S DRIVE TOGETHER



SOJADIS

Taking your children to school, to a basketball match, meeting up with friends, going away for the weekend... We all aspire to be able to get around easily, to be able to cope with everyday life without depending on others, to be able to fulfil our potential as women or men - in short, to lead our own lives.

DRIVE YOUR LIFE* is the philosophy that drives the entire Sojadis team:

«Our company develops and manufactures technical solutions, embodying knowledge and expertise in cutting-edge electronics that are as rare as they are precious. But what adds value to this expertise is our desire to enable as many people as possible to drive in complete safety and with complete peace of mind, so that they can fulfil their life's plans.»

Adeline HUMEAU, President of Sojadis

*Drive Your Life is the Sojadis slogan.



**LEAVE US
YOUR OPINION**

Your opinion counts.

Help us to improve by sharing your impressions.
Thank you !



Click here or scan the QR-Code

Safetrip!



GLOSSARY

KICKDOWN

Kickdown is a function of automatic cars that reduces the gear down when the accelerator is fully depressed.

ACTIVATION BUTTON

The activation button turns red when the equipment is active. Note that this is not an on/off button. To deactivate the equipment, the vehicle's engine must be switched off.



SOJADIS PARTNER INSTALLER

Partner installers are car garages that have chosen to join the Sojadis network to offer their customers vehicle adaptations for people with disabilities and driving school conversions.

They are all trained and supported by Sojadis to guarantee the quality of the products and services offered. Thanks to this network, every customer can benefit from Sojadis' expertise and values, close to home.



FOR MORE INFORMATION

Click or scan
the QR-Code

CONTACT

 Place du Maréchal Leclerc
Jallais
49510 BEAUPRÉAU-EN-MAUGES
FRANCE

 +33 2 41 64 05 58

 sojadis@sojadis.com

 www.sojadis.com

Follow us on our social networks





www.sojadis.com

ACCELEVO

HANDGAS UND BREMSE

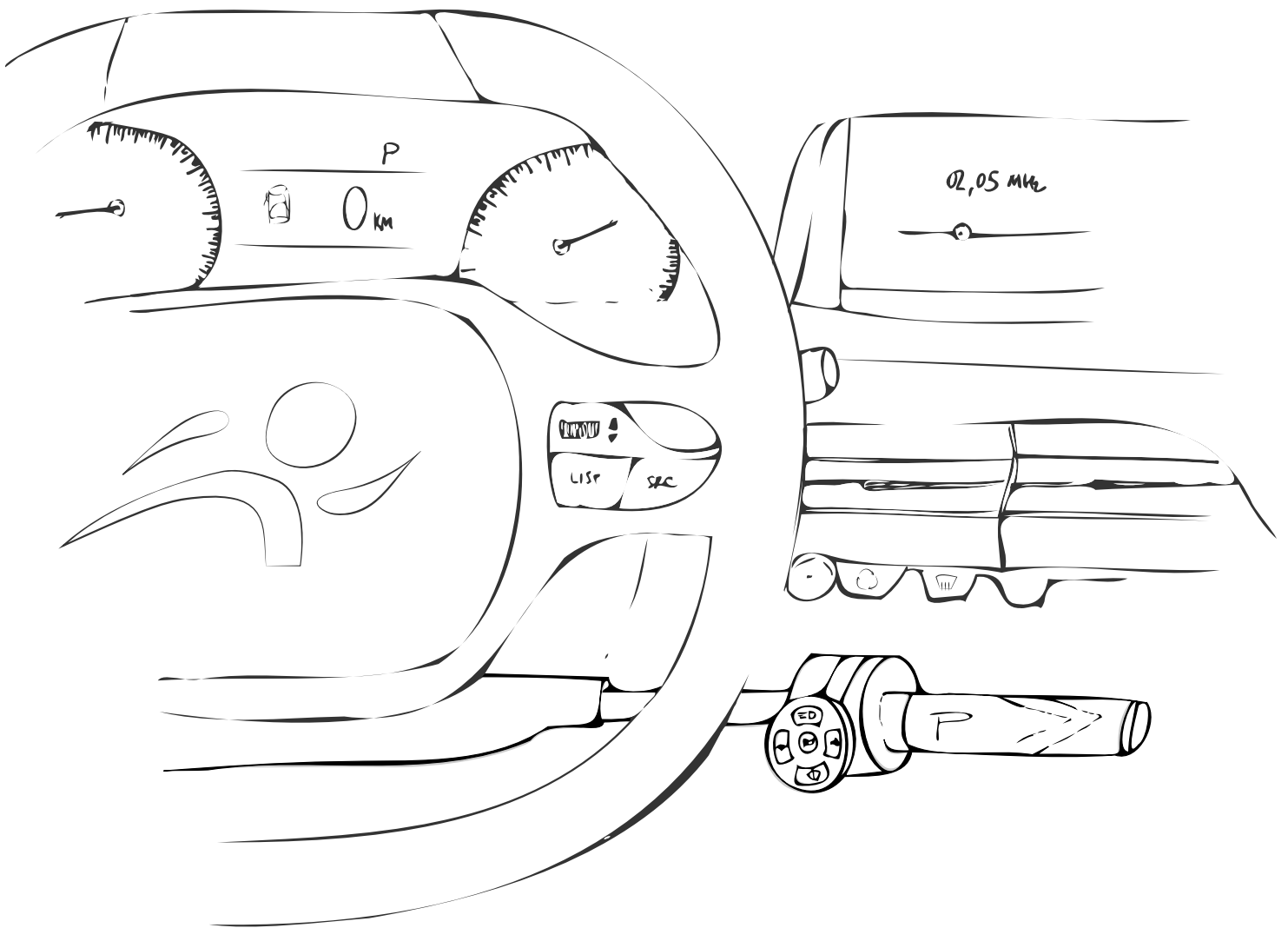

sojadis
PLUG & DRIVE

www.sojadis.com



INHALTS

ACCELEVO in Kürze	27
Verwendung	28
Wartung	30
Garantie	31
Pannen und Lösungen	32
Gemeinsam unterwegs	33
Glossar	34

Sehr geehrter Kunde,
Sie haben gerade ein Sojadis-Gerät erworben und wir danken Ihnen für Ihr Vertrauen. Wir wünschen Ihnen eine gute Fahrt mit Ihrem Fahrzeug und Ihrer neuen Ausstattung.

Sojadis-Team



ACCELEVO IN KÜRZE

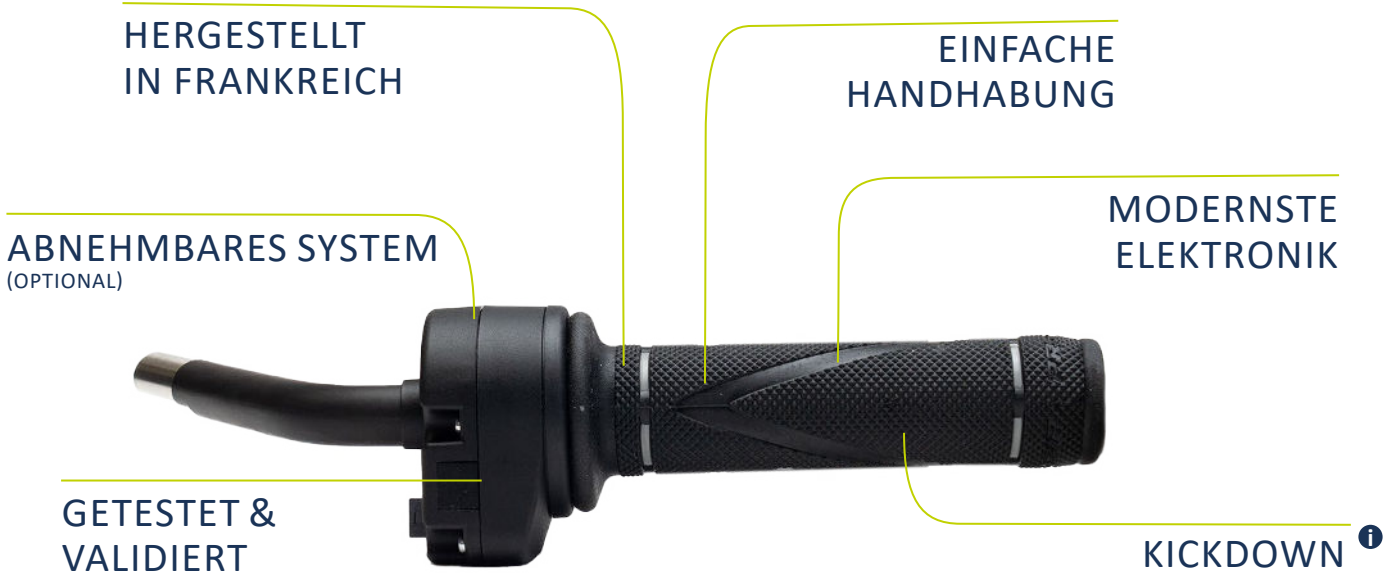

MINITASTATUR (OPTIONAL) :





VERWENDUNG



EMPFEHLUNGEN

AKTIVIERUNG

Das Gerät muss innerhalb von 30 Sekunden aktiviert werden. Andernfalls Fahrzeug neu starten und die Schritte wiederholen.

Infolge der Aktivierung von ACCELEVO ist das originale Gaspedal deaktiviert.



BEGINNEN SIE

Berühren Sie das ACCELEVO beim Starten des Fahrzeugs nicht.

MINITASTATUR

Beim Anfahren des Fahrzeugs ist die MINI-TASTE des ACCELEVO aktiv, im Gegensatz zum ACCELEVO, das inaktiv ist (keine Beschleunigung).

BEDIENUNGSANLEITUNG

1 FAHRZEUG
STARTEN

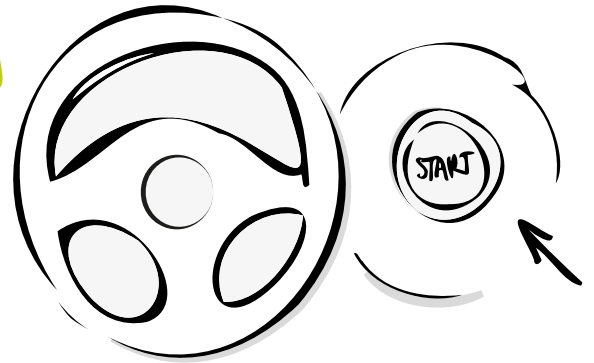

2 AKTIVIERUNGSKNOPF
DRÜCKEN ⁱ

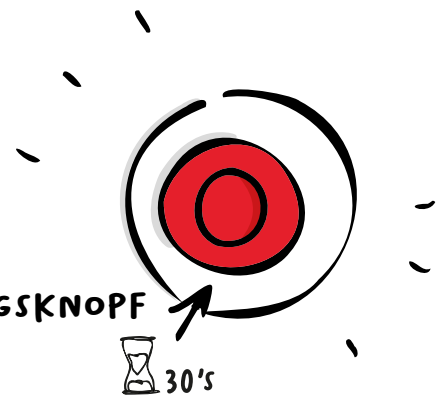

3 IHRE AUSTRÜSTUNG
BENUTZEN

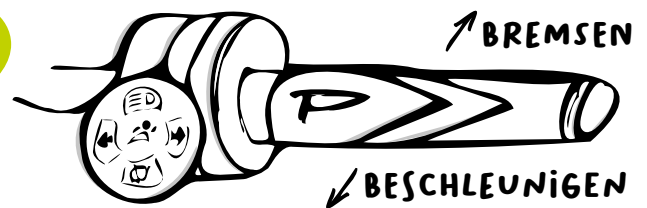

BEVORZUGEN SIE
EIN VIDEO?

Klicken Sie hier oder
scannen Sie den QR-Code.





SICHERHEIT

Dank der Elektronik im ACCEL QUAD wird beim Bremsen automatisch die Beschleunigung deaktiviert.



ZURÜCK ZUR ORIGINALEN KONFIGURATION

Um in die originale Konfiguration zurückzukehren (Anpassungsausrüstung deaktiviert), stellen Sie den Motor ab und starten Sie das Fahrzeug neu.



TEMPOBEGRENZER

Um den Geschwindigkeitsbegrenzer zu deaktivieren (beispielsweise beim Überholen), drücken Sie kräftig auf das Gaspedal.



MONTAGE UND DEMONTAGE

(OPTIONAL)

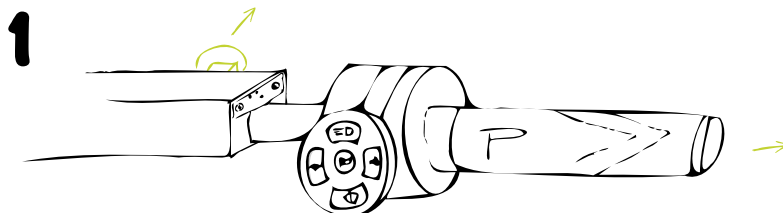

2

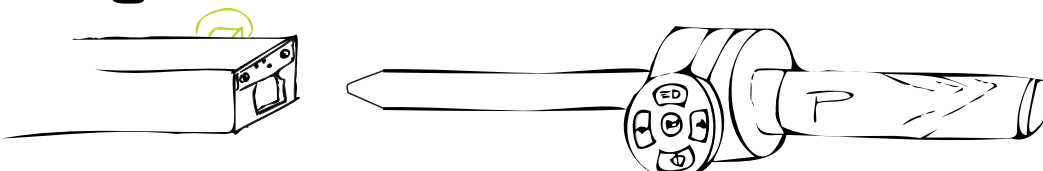

MINITASTATUR (OPTIONAL)



AKTIVIERUNG & DEAKTIVIERUNG

Wenn eine Funktion mit dem MINI-TASTE aktiviert wird, muss sie unbedingt auch mit dem MINI-TASTE deaktiviert werden.

Wenn der Motor des Fahrzeugs abgestellt wird, werden die Bedienelemente MINI-TASTE, die gerade verwendet werden, automatisch ausgeschaltet. Je nach Ihrer Konfiguration können die Funktionen beim nächsten Start wieder aktiviert werden.



BREMSBLOCKADE

Ziehen Sie niemals am Bremshebel, um die Bremse zu lösen. Befolgen Sie die Methode zum Blockieren/Entsperren auf Seite 29 der STOPDIS-Anleitung.



WARTUNG

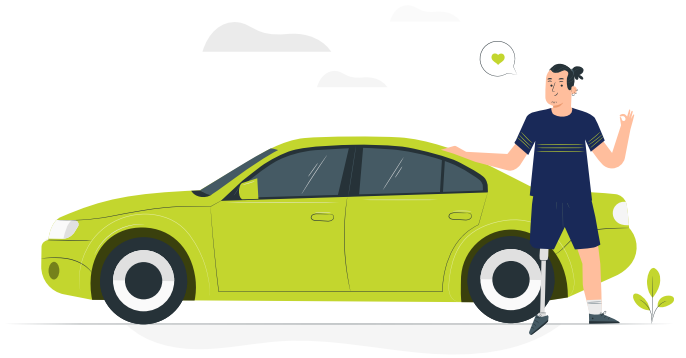

UNSERE TIPPS



REINIGUNG

Der ACCELEVO benötigt keine besondere Wartung.
Vorsicht: Die Verwendung von Reinigungsmitteln kann die Funktion des Geräts beeinträchtigen.



ENTSTAUBUNG

Verwenden Sie zum Abstauben des ACCELEVO ein weiches Mikrofaser Tuch.

Für Wartungsarbeiten wenden Sie sich bitte an unsere Werkstatt oder einen Sojadis-Partnerinstallateur. ¹



GARANTIE



IN KÜRZE

2
JAHRE

Dies ist die Frist, innerhalb derer die gesetzliche Gewährleistung gilt.



Die gesetzliche Konformitätsgarantie berechtigt Sie zur Reparatur oder zum Austausch des Produkts. Wenden Sie sich an Ihren Installationspartner, um die Frist zu erfahren.



Die Garantie gilt nicht in den folgenden Fällen: Missbrauch des Produkts, Unfall usw.

MEHR ERFAHREN



RÜCKGABE VON AUSRÜSTUNG

Sie möchten Ihr ausgestattetes Fahrzeug verkaufen oder Ihre Ausrüstung abgeben?

Wenden Sie sich an Sojadis oder Ihren lokalen Partner.



PRODUKTVALIDIERUNG

Erfahren Sie, was wir tun, um die Zuverlässigkeit unserer Geräte während des gesamten Entwicklungsprozesses zu testen und zu bestätigen.



Klicken Sie hier oder scannen Sie den QR-Code.



PANNEN UND LÖSUNGEN



KUNDENDIENST

Unser Kundendienst steht Ihnen zur Verfügung, um Diagnosen zu stellen, Fehler zu beheben und Lösungen für Ihre Fragen zu finden. Halten Sie im Falle eines Kundendienstes Ihren Fahrzeugschein bereit.



+33 2 41 64 05 58

(Montag bis Donnerstag von 8:30 bis 18:00 Uhr und Freitag von 8:30 bis 17:00 Uhr)



sojadis@sojadis.com



www.sojadis.com

(über unser Kontaktformular)



SELBSTDIAGNOSE



Nach dem Starten meines Autos funktioniert meine Ausrüstung nicht

Überprüfen Sie die Funktion des Aktivierungsknopfes (roter Knopf) siehe Seite Bedienungsanleitung.



Die Motorfehleranzeige erscheint auf meinem Armaturenbrett

Kontaktieren Sie uns oder wenden Sie sich an Ihren nächstgelegenen Installateur.

Meine Beschleunigung ist nicht flüssig

Ihre ACCELEVO hat Schwierigkeiten zu gleiten. Kontaktieren Sie uns oder wenden Sie sich an einen Sojadis-Partnerinstallateur in Ihrer Nähe.



INSTALLATEURNETZWERK

Wenden Sie sich bei einer Panne direkt an die Sojadis-Werkstatt oder an den Sojadis-Partnerinstallateur, der die Anpassung des Fahrzeugs vorgenommen hat.



KARTE PARTNERINSTALLATEUR

Klicken Sie hier oder scannen Sie den QR-Code.

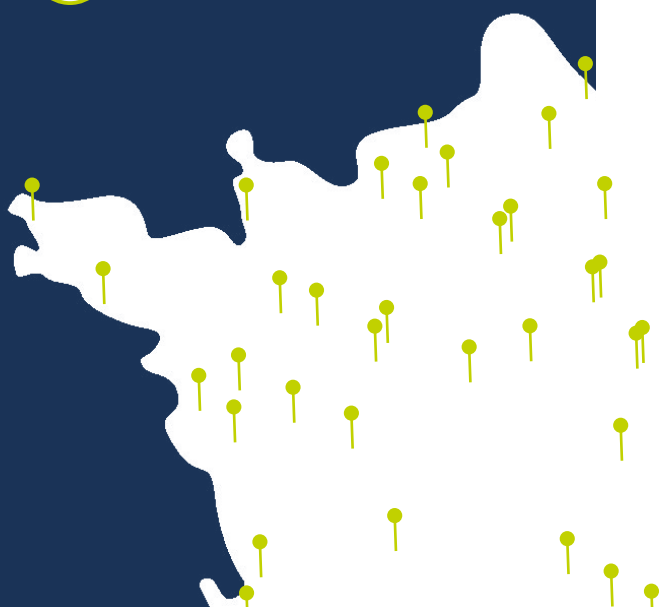



GEMEINSAM UNTERWEGS



SOJADIS

Die Kinder zur Schule oder zum Basketballspiel bringen, sich mit Freunden treffen, einen Wochenendausflug machen... Wir alle sehnen uns danach, uns leicht fortbewegen zu können, den Alltag bewältigen zu können, ohne von anderen abhängig zu sein, uns als Mensch verwirklichen zu können, kurz gesagt, unser Leben zu führen.

DRIVE YOUR LIFE*, das ist die Philosophie, die das gesamte Team von Sojadis antreibt:
«Unser Unternehmen entwickelt und produziert technische Lösungen, die Fachwissen und Know-how im Bereich der Spitzenelektronik beinhalten. Aber was den Mehrwert dieses Fachwissens ausmacht, ist unser Bestreben, möglichst vielen Menschen zu ermöglichen, Sicher und entspannt fahren zu können, um ihre Lebensprojekte zu verwirklichen.»

Adeline HUMTEAU, CEO

*Drive Your Life ist der Slogan von Sojadis. Es bedeutet „Führe dein Leben“.



IHRE MEINUNG ZÄHLT

Ihre Meinung zählt. Helfen Sie uns, uns zu verbessern, indem Sie uns Ihre Meinung mitteilen. **Vielen Dank im Voraus!**



Klicken Sie hier oder scannen Sie den QR-Code.

Gute Fahrt



GLOSSAR

KICKDOWN

Der Kickdown ist eine Funktion von Automatikfahrzeugen, die den Gang herunterschaltet, wenn das Gaspedal voll durchgetreten wird.

AKTIVIERUNGSKNOPF

Die Aktivierungsschaltfläche wird rot, wenn die Ausrüstung aktiv ist. Achtung, es handelt sich nicht um eine Ein/Aus-Taste.

Um die Ausrüstung zu deaktivieren, müssen Sie den Motor des Fahrzeugs ausschalten.

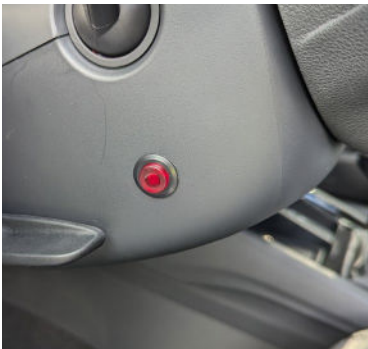

SOJADIS-PARTNERINSTALLATEUR

Die Partner-Installateure sind Autowerkstätten, die sich dem Sojadis-Netzwerk angeschlossen haben, um ihren Kunden Fahrzeugumbauten für Menschen mit Behinderung und Umbauten für Fahrschulen anzubieten. Sie werden alle von Sojadis geschult und begleitet, um die Qualität der angebotenen Produkte und Dienstleistungen zu gewährleisten. Dank dieses Netzwerks kann jeder Kunde in seiner Nähe von der Expertise und den Werten von Sojadis profitieren.



WEITERE INFORMATIONEN

Klicken Sie hier oder
scannen Sie den QR-Code.

KONTAKT

 Place du Maréchal Leclerc
Jallais
49510 BEAUPRÉAU-EN-MAUGES
FRANKREICH

 +33 2 41 64 05 58

 sojadis@sojadis.com

 www.sojadis.com

*Folgen Sie uns auf unseren
sozialen Netzwerken*





www.sojadis.com

ACCELEVO

MANDO ACCELERADOR Y FRENO

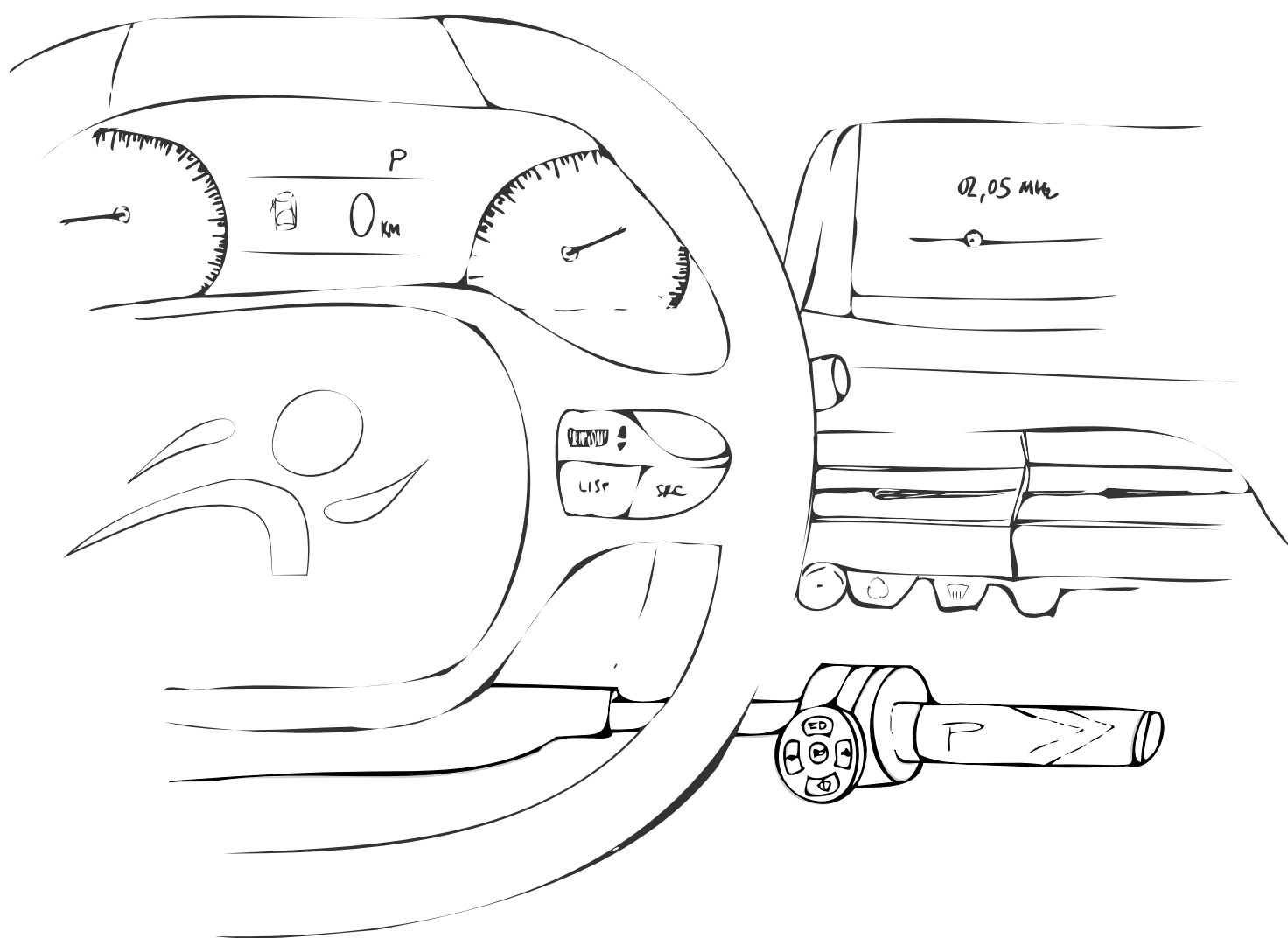

sojadis
PLUG & DRIVE

www.sojadis.com



CONTENIDO

Resumen del ACCELEVO	39
Uso	40
Mantenimiento	42
Garantía	43
Fallos y soluciones	44
Avancemos juntos	45
Glosario	46



Estimado cliente,
Acaba de adquirir un equipo Sojadis y le agradecemos su confianza.

Le deseamos buen viaje con su vehículo y su nuevo equipo.

El equipo Sojadis

RESUMEN DEL ACCELEVO

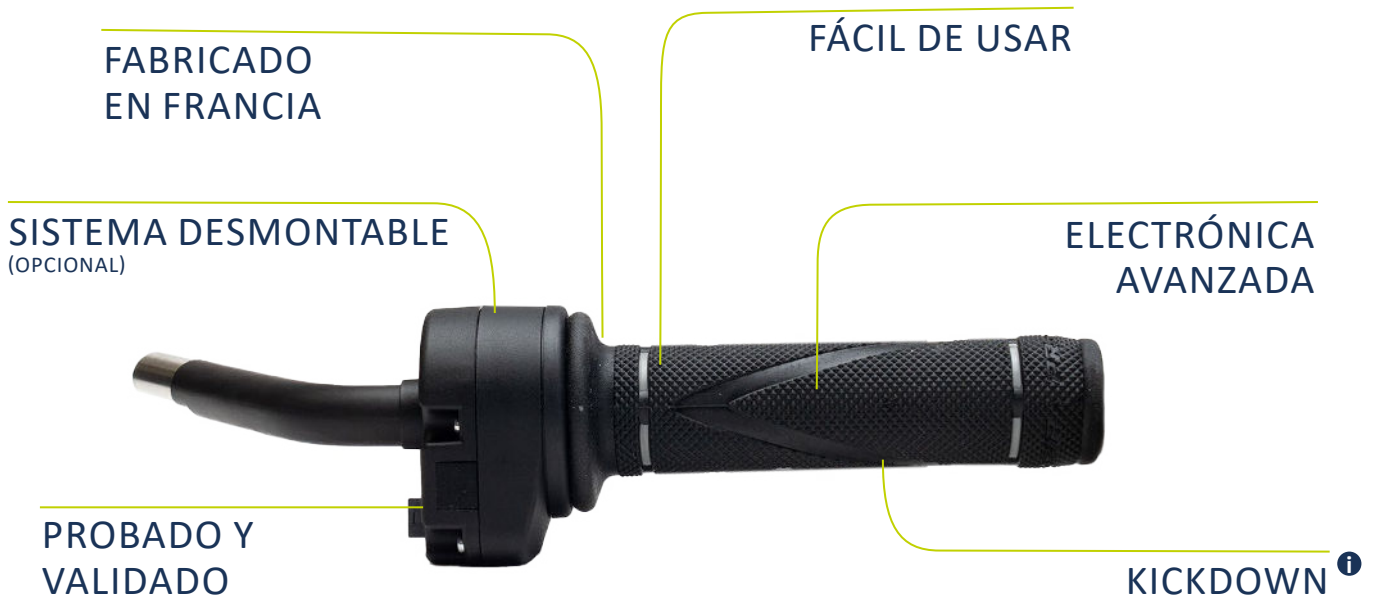

MINI-TECLADO (OPCIONAL) :





USO



RECOMENDACIONES

ACTIVACIÓN

El equipo debe activarse antes de 30 segundos. Después de eso, el vehículo debe volver a arrancar y repetir los pasos de las instrucciones de uso.

Al activar ACCELEVO, el pedal original del acelerador queda deshabilitado automáticamente.



ARRANCAR

No toque el ACCELEVO al arrancar el vehículo.

MINI-TECLADO

Al arrancar el vehículo, el MINI-TECLADO de ACCELEVO está activo, mientras que el ACCELEVO está inactivo (no hay aceleración).

INSTRUCCIONES DE USO

1 ARRANCAR EL VEHÍCULO

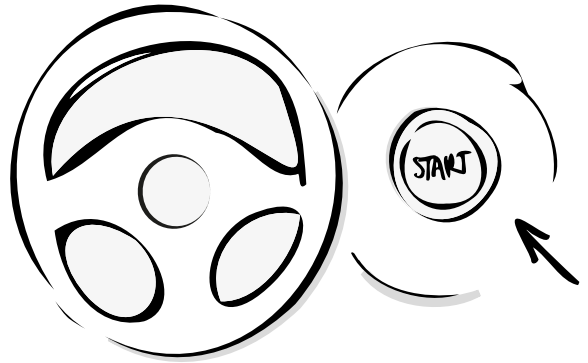

2 PULSAR EL BOTÓN DE ACTIVACIÓN

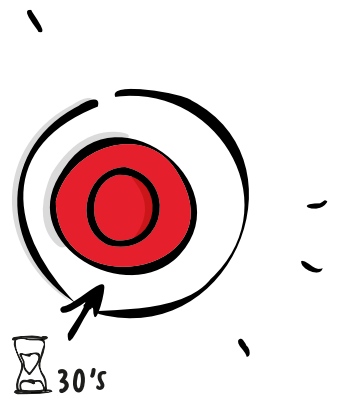

3 UTILIZAR EL EQUIPO

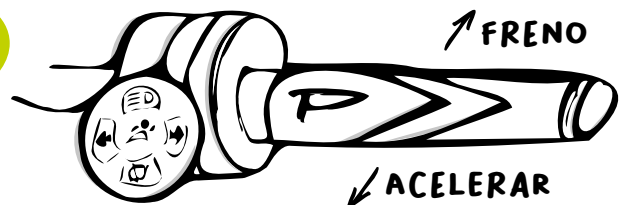

¿PREFIERE UN VÍDEO?

Haga clic aquí o escanee el código QR.





SEGURIDAD

Gracias a la electrónica de a bordo del ACCELEVO, el frenado desactiva automáticamente la aceleración.



VOLVER A CONFIGURACIÓN ORIGINAL

Para volver a la configuración original, apague el motor y vuelva a arrancar el vehículo.



LIMITADOR DE VELOCIDAD

Para desactivar el limitador de velocidad (por ejemplo, al adelantar), pisa a fondo el acelerador.



MONTAJE Y DESMONTAJE

(OPCIONAL)

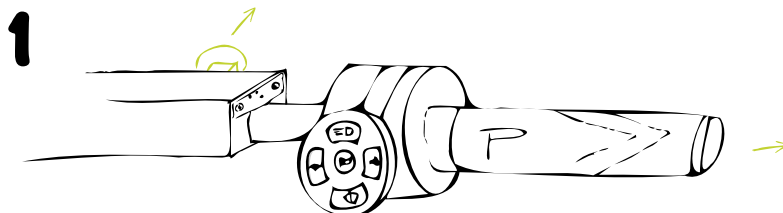

2

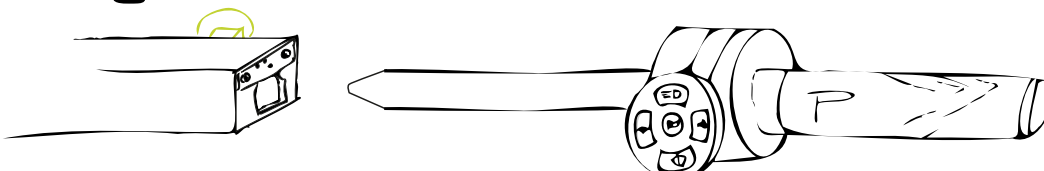

MINI-TECLADO

(OPCIONAL)



ACTIVACIÓN & DESACTIVACIÓN

Cuando una función se activa con el MINI-TECLADO, debe desactivarse con este último.

Cuando se apaga el motor del vehículo, se desconectan automáticamente los mandos del MINI-TECLADO que se estén utilizando. Dependiendo de su configuración, las funciones pueden reactivarse la próxima vez que se arranque el vehículo.



BLOQUEO DE FRENO

No accione el freno para desbloquearlo. Siga las instrucciones en la página 41 del manual STOPDIS.



MANTENIMIENTO

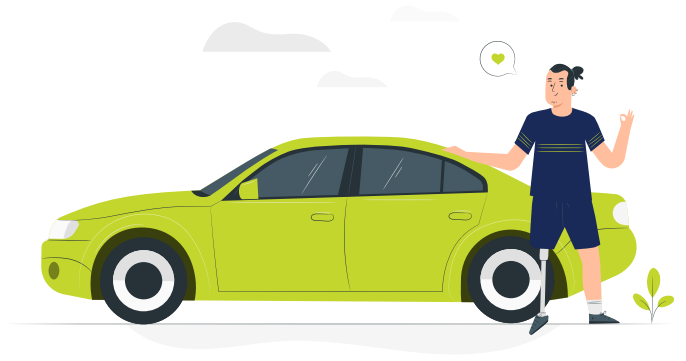

NUESTRO CONSEJO



LIMPIEZA

ACCELEVO no requiere ningún mantenimiento especial.

Precaución: el uso de productos puede dañar el funcionamiento del equipo.



ELIMINACIÓN DEL POLVO

Para eliminar el polvo del ACCELEVO, utilice un paño suave de microfibra.

Para cualquier tarea de mantenimiento, póngase en contacto con nuestro taller o con un instalador asociado de Sojadis. ⁱ



GARANTÍA



RESUMEN

2
AÑOS

Es el periodo de aplicación de la garantía legal.



La garantía legal de conformidad da derecho a la reparación o sustitución del producto. Póngase en contacto con su instalador asociado para conocer el plazo.



La garantía no se aplica en los siguientes casos: uso indebido del producto, accidente, etc.

MÁS INFORMACIÓN



DESMONTAJE

¿Quiere vender su vehículo equipado o desmontar su equipo? Póngase en contacto con Sojadis o con su socio local.



VALIDACIÓN DE PRODUCTOS

Descubra lo que hacemos para probar y validar la fiabilidad de nuestros equipos durante toda la fase de diseño.



Haga clic aquí o escanee el código QR



FALLOS Y SOLUCIONES



SERVICIO POSVENTA

Nuestro servicio posventa está a su disposición para diagnosticar, localizar averías y encontrar soluciones a sus problemas. Lleve consigo el permiso de circulación en caso de servicio posventa.



+33 2 41 64 05 58

(de lunes a jueves de 8.30 a 18.00 y viernes de 8.30 a 17.00)



sojadis@sojadis.com



www.sojadis.com

(a través de nuestro formulario de contacto)



AUTODIAGNÓSTICO



Cuando arranco el coche, el equipo no funciona

Compruebe que el botón de activación (botón rojo) funciona (consulte la página de instrucciones de funcionamiento).



El testigo de avería del motor aparece en mi salpicadero

Póngase en contacto con nosotros o con su instalador Sojadis más cercano.

Mi aceleración no es suave

Su ACCELEVO tiene problemas de deslizamiento. Póngase en contacto con nosotros o con su instalador asociado Sojadis más cercano.



RED DE INSTALADORES

En caso de avería, póngase en contacto directamente con el taller Sojadis o con el instalador asociado Sojadis que montó el vehículo.



TARJETA DE INSTALADOR ASOCIADO

Haga clic aquí o escanee el código QR.



AVANCEMOS JUNTOS

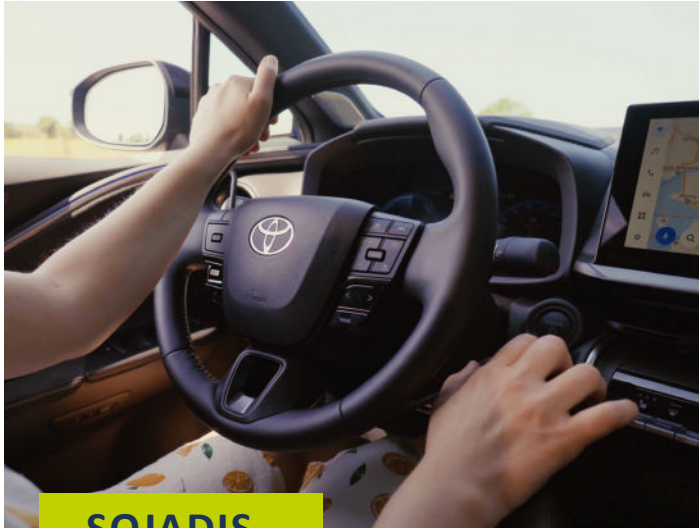

SOJADIS

Llevar a los niños al colegio, ir a un partido de baloncesto, quedar con los amigos, salir de fin de semana... Todos aspiramos a poder desplazarnos con facilidad, a poder afrontar la vida cotidiana sin depender de los demás, a poder desarrollar nuestro potencial como mujeres u hombres; en definitiva, a llevar nuestra propia vida.

DRIVE YOUR LIFE*, es la filosofía que motiva a todo el equipo de Sojadis:

«Nuestra empresa desarrolla y fabrica soluciones técnicas, que encarnan unos conocimientos y un saber hacer en electrónica de vanguardia tan escasos como inestimables. Pero lo que añade valor a esta experiencia es nuestro deseo de permitir que el mayor número posible de personas conduzcan con total seguridad y tranquilidad, para que puedan cumplir sus proyectos vitales.»

Adeline HUMTEAU, CEO de Sojadis

*Drive Your Life es el lema de Sojadis. Significa «Dirige tu vida».



**DÉJENOS SU
OPINIÓN**

Ayúdenos a mejorar compartiendo sus impresiones. ¡Gracias!



Haga clic aquí o escanee el código QR.

Buen viaje



GLOSARIO

KICKDOWN

El kickdown es una función de los coches automáticos que reduce la velocidad cuando se pisa a fondo el acelerador.

BOTÓN DE ACTIVACIÓN

Se vuelve rojo cuando el equipo está activo. No es un botón on/off. Para desactivar, apague el motor.



INSTALADOR ASOCIADO DE SOJADIS

Los instaladores asociados son talleres mecánicos que han decidido unirse a la red Sojadis para ofrecer a sus clientes adaptaciones de vehículos para personas con discapacidad y transformaciones para autoescuelas.

Todos ellos han recibido formación y asesoramiento por parte de Sojadis con el fin de garantizar la calidad de los productos y servicios ofrecidos. Gracias a esta red, cada cliente puede beneficiarse de la experiencia y los valores de Sojadis cerca de su domicilio.



PARA MÁS INFORMACIÓN

Haga clic aquí o escanee el código QR.

CONTACTO

 Place du Maréchal Leclerc
Jallais
49510 BEAUPRÉAU-EN-MAUGES
FRANCIA

 +33 2 41 64 05 58

 sojadis@sojadis.com

 www.sojadis.com

Siganos en nuestras redes sociales





www.sojadis.com